

Business Market & Outlook

June 2014



Disclaimer

The business results are subject to the IFRS(International Financial Reporting Standards) from 2010. In addition, operating profits are amended to reflect revisions of “K-IFRS, No. 1001” decided on 19th regular Financial Services Commission’s meeting on October 17th 2012 and “Guidance for public announcements of business results” reported by KAI(Korea Accounting Institute) on Feb 18th 2013.

Forecasts and projections contained in this material are based on current business environments and management’s strategies, and they may differ from the actual results upon changes and unaccounted variables.

Table of Contents

LG Chem at a Glance	1
1Q 2014 Business Results	3
Divisional Results & Outlook	5
Appendix	7

LG Chem at a Glance

- LG Chem was started in 1947 and is Korea's first and largest chemical company with an established track of over 60 years and annual revenues of KRW 23.1 trillion in 2013.
- LG Chem boasts multiple production facilities and an extensive distribution network that spans 15 countries worldwide in Asia, Europe, North and South America.
- LG Chem currently holds the largest vertically integrated petrochemical production platform in Korea.
- LG Chem was reborn as a specialized and diversified chemical company that focuses on petrochemical goods, rechargeable batteries including HEV/EV purpose, OLED materials, and 3D FPR.
- LG Chem will seek operational excellence in its core business and centralize its resources with new business such as xEV batteries and LCD glass substrates to reinforce the necessary momentum for future growth.
- Despite high uncertainties remaining in the business environment such as delayed recovery in the global economy, LG Chem is recording robust profitability compared to peers.

Revenue Growth*

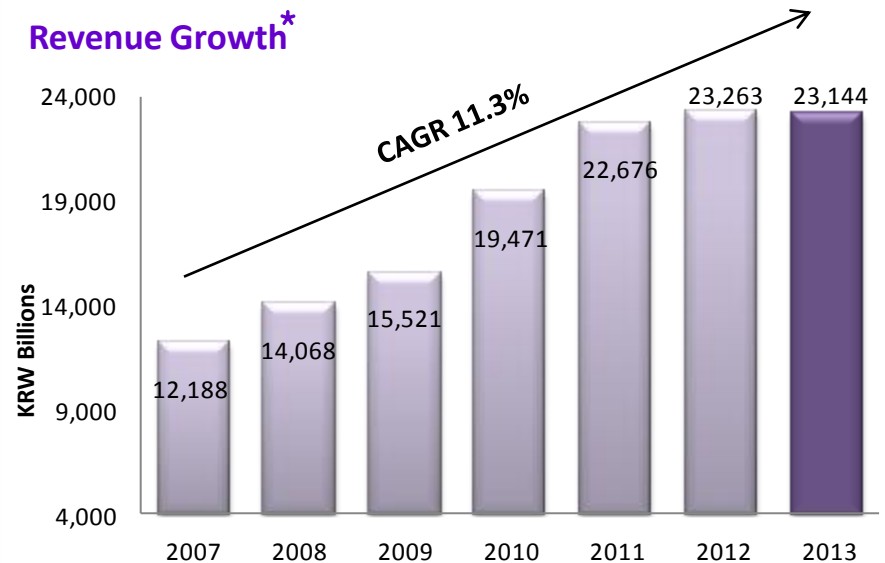

...with Strong EBIT & EBIT Margins*

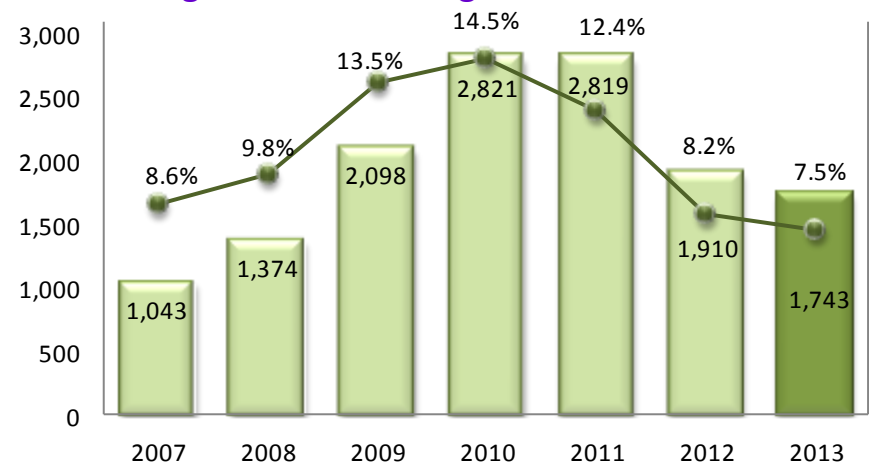

* Sales and EBIT are subject to IFRS from 2009. Those prior to 2009 are subject to K-GAAP(consolidated base).

Differentiated Competitiveness

Vertical Integration Structure

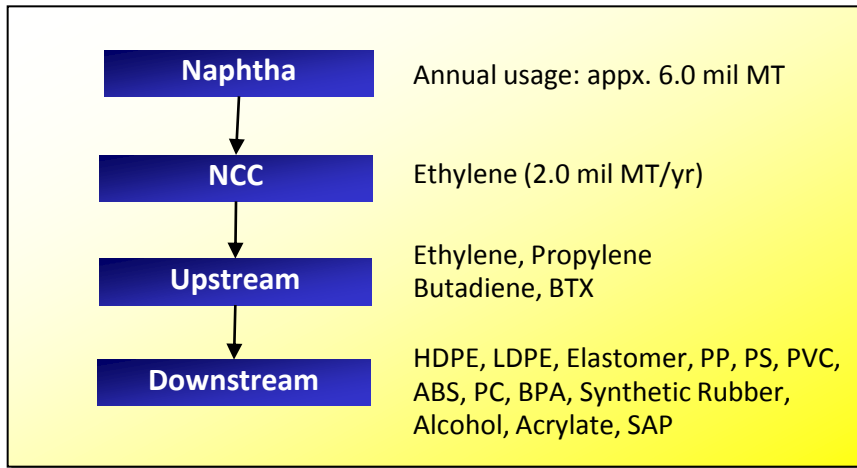

Co-existence of upstream and downstream products

- One of few petrochemical companies around the globe with vertical integration structure, featuring both upstream and downstream production capability.
- This structural characteristic delivers stable business performance against industry cyclicality.

Comprehensive downstream product lines

LG Chem's comprehensive downstream product lines of PO, ABS, PVC and other various products have complementary business cycles, enabling the Company to generate stable revenue



Stabilized revenue generating capability under any market conditions

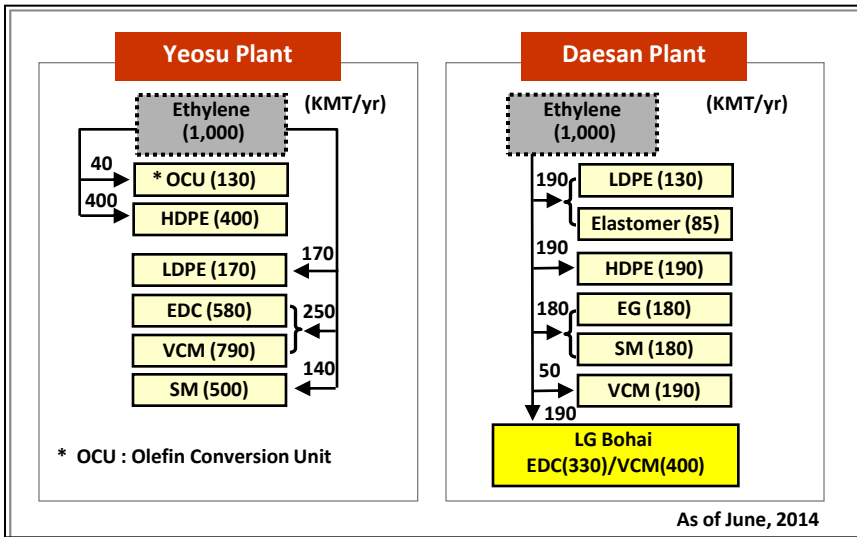

(Unit: KRW bn)

Classification	'13.1Q	'13.4Q	'14.1Q	YoY	QoQ
Sales	5,721	5,641	5,673	-0.8%	0.6%
Operating Profit	409	316	362	-11.4%	14.5%
(%)	(7.1)	(5.6)	(6.4)		
Pre-tax Income	415	236	354	-14.6%	50.0%
(%)	(7.2)	(4.2)	(6.2)		
Net Income	340	177	286	-16.0%	61.7%

Financial Position

(Unit: KRW bn)

Classification	'13	'14.1Q	Change
Asset	17,447	18,288	4.8%
Cash and equivalents	1,909	2,147	12.5%
Liabilities	5,721	6,594	15.3%
Borrowings	3,011	3,348	11.2%
Shareholder's Equity	11,726	11,694	-0.3%
EBITDA	2,788	632	

Financial Ratios

Classification	'13	'14.1Q	Change
Total Liabilities/ Equity (%)	48.8	56.4	7.6%p
Borrowings / Equity (%)	25.7	28.6	2.9%p
Interest Coverage Ratio (x)	26.7	17.9	-8.8
ROE (%)	11.3	9.8	-1.5%p
ROA (%)	7.5	6.4	-1.1%p

Business results

(Unit: KRW bn)

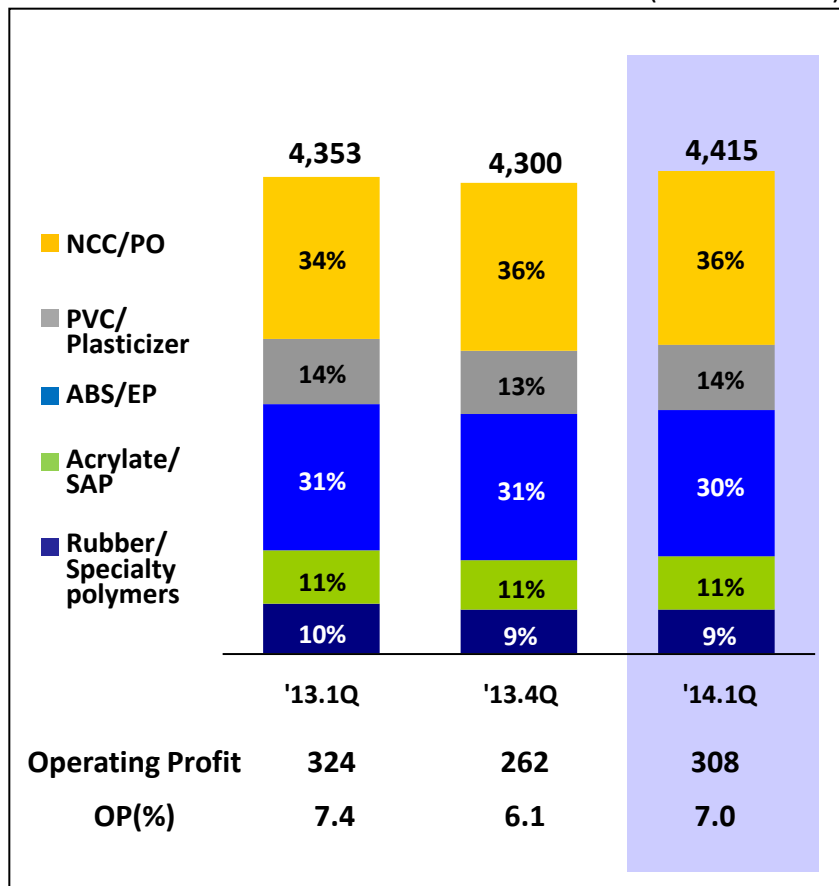

Analysis

• Analysis

■ Earnings improved by differentiated product mix despite the slow recovery of market

-NCC/PO : Earnings improved with strong PE spread maintained by supply tightness amid maintenance shut-down

-PVC/Plasticizer : Recovery of profits slowed due to weak demand and cost burden of ethylene

-ABS/EP : Margin Improved through increased premium product sales

-Acrylate/SAP : Secured solid profits by capacity expansion of SAP

-Rubber/Specialty Polymers : Price decreased due to weak tire demand continued

• Outlook

■ Expect gradual market recovery with seasonal demand

■ Expect better business results than peers through expanding premium products sales

Business results

Analysis

(Unit: KRW bn)

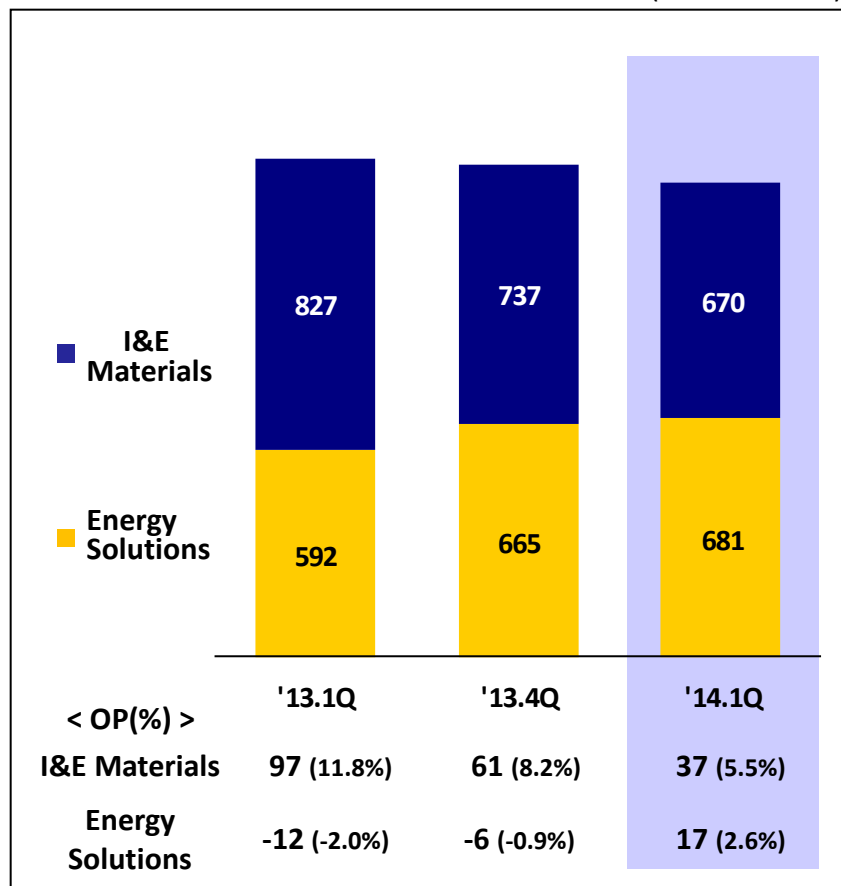

• Analysis

■ **I&E earnings decreased due to slow panel demand, while Energy Solutions recorded sound results thanks to operating ratio rises of mobile batteries**

- **I&E Materials** : Recorded sluggish earnings due to polarizer shipments decrease stemming from inventory adjustment of panels
- **Energy Solutions** : Improved results with utilization rate rises of mobile batteries despite the off-season

• Outlook

■ **Improving performances due to the beginning of peak season and the benefit of capacity additions**

- **I&E Materials** : Achieve better results based on the operation start of new polarizer line in Nanjing & production stabilization
- **Energy Solutions** : Continue to diversify applications such as power tools and power banks, while increasing shipments of polymer and large-size prismatic & expand sales of automotive battery

(Unit: KRW bn)

Classification	2013					2014				
	1Q	2Q	3Q	4Q	Total	1Q	2Q	3Q	4Q	Total
Sales	5,721	5,917	5,865	5,641	23,144	5,673				5,673
Operating Profit	409	502	516	316	1,743	362				362
Petrochemicals	4,353	4,536	4,426	4,300	17,614	4,415				4,415
NCC/PO	1,470	1,509	1,517	1,540	6,036	1,586				1,586
PVC/Plasticizer	598	620	611	580	2,409	601				601
ABS	1,082	1,165	1,099	1,051	4,396	1,066				1,066
EP	265	282	284	271	1,102	282				282
Acrylate/SAP	492	511	504	460	1,966	474				474
Rubber/ Specialty Polymer	446	450	412	398	1,706	406				406
Operating Profit	324	367	380	262	1,332	308				308
I&E Materials	827	813	788	737	3,166	670				670
Operating Profit	97	119	102	61	379	37				37
Energy Solutions	592	619	708	665	2,583	681				681
Operating Profit	-12	16	34	-6	32	17				17

※ 2013 Petrochemicals business results are amended to reflect reorganization of the division.

Borrowings

(Unit : KRW bn)

Classification	'13	'14.1Q
Total (Overseas Subsidiaries)	3,011 (1,172) 100%	3,348 (1,324) 100%
KRW Currency	803 27%	803 24%
C P	599	599
Others	205	204
Foreign Currency	2,207 73%	2,545 76%
Loan	1,272	1,423
Negotiation Borrowings	935	1,122
Short-term (Overseas Subsidiaries)	2,207 (1,074) 73%	2,531 (1,115) 76%
Long-term (Overseas Subsidiaries)	803 (98) 27%	817 (209) 24%

* The % is calculated to total borrowings.

Cash Flow

(Unit: KRW bn)

Classification	'13	'14.1Q
Beginning Cash	1,341	1,909
Operating/Investing	813	-99
Net Income	1,271	286
Depreciation	1,045	270
Working Capital	-280	-470
CAPEX	-1,380	-277
Others	157	92
Financing	-245	337
Borrowings	64	337
Dividends	-308	-
Ending	1,909	2,147

(Unit: KRW bn)

Classification		'12	'13	'14 Plan	'14.1Q
Petrochemicals	New / Expansion	784	405	483	72
	Maintenance	226	224	410	56
	Total	1,009	628	894	128
I & E Materials	New / Expansion	242	254	410	34
	Maintenance	90	109	176	38
	Total	332	363	586	72
Energy Solutions	New / Expansion	395	96	64	29
	Maintenance	138	110	132	28
	Total	533	206	196	57
Common Expenses	New / Expansion	16	6	9	-
	Maintenance	185	177	267	21
	Total	201	184	276	21
Total	New / Expansion	1,436	761	966	135
	Maintenance	639	619	985	143
	Total	2,075	1,380	1,951	277

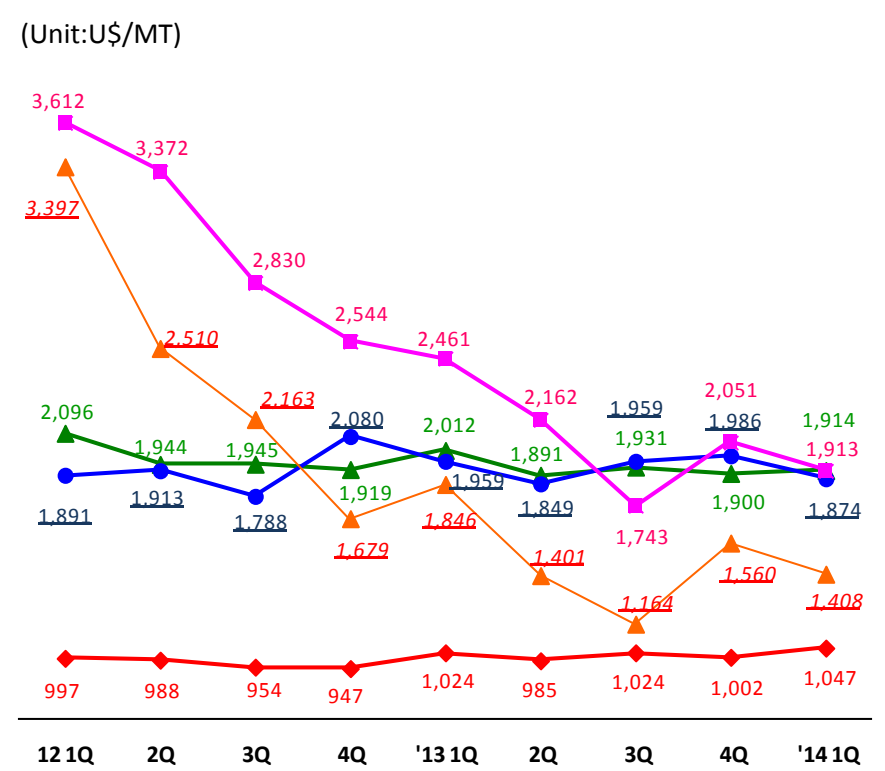
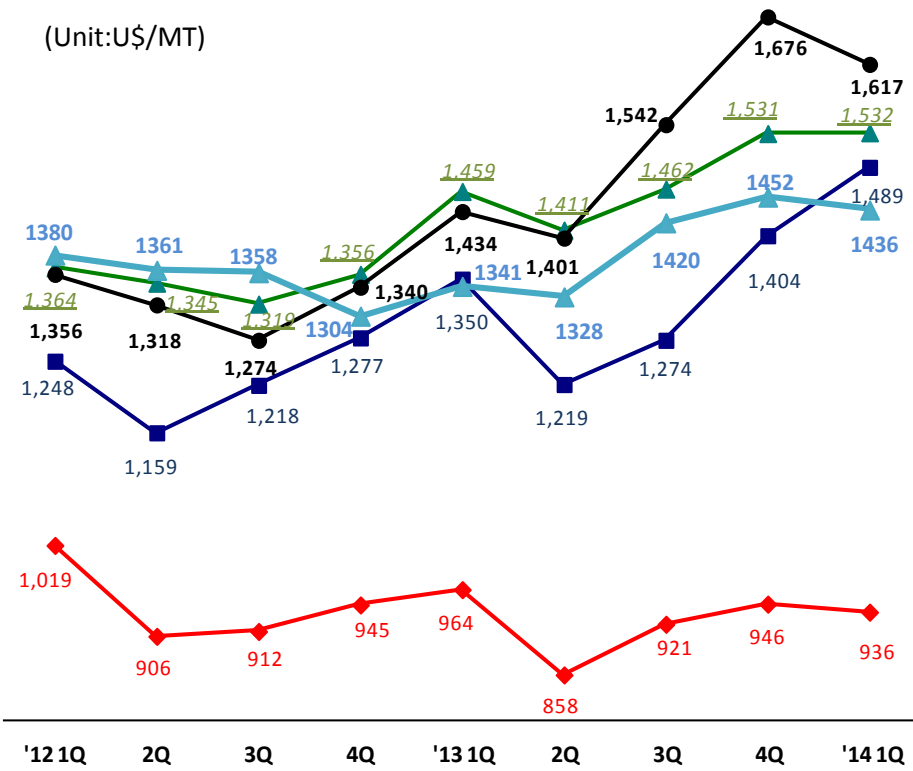

◆ Naphtha
 ■ Ethylene
 ▲ HDPE(Film)
 ● LDPE
 ▲ Propylene

◆ PVC
 ▲ ABS
 ● B.Acrylate
 ▲ BD
 ■ BR

NCC/PO

PVC/
Plasticizer

ABS/EP

Acrylate/
SAP

Rubber/
Specialty Polymers

• The prices are average price of CFR FE Asia for general grade in each product group.

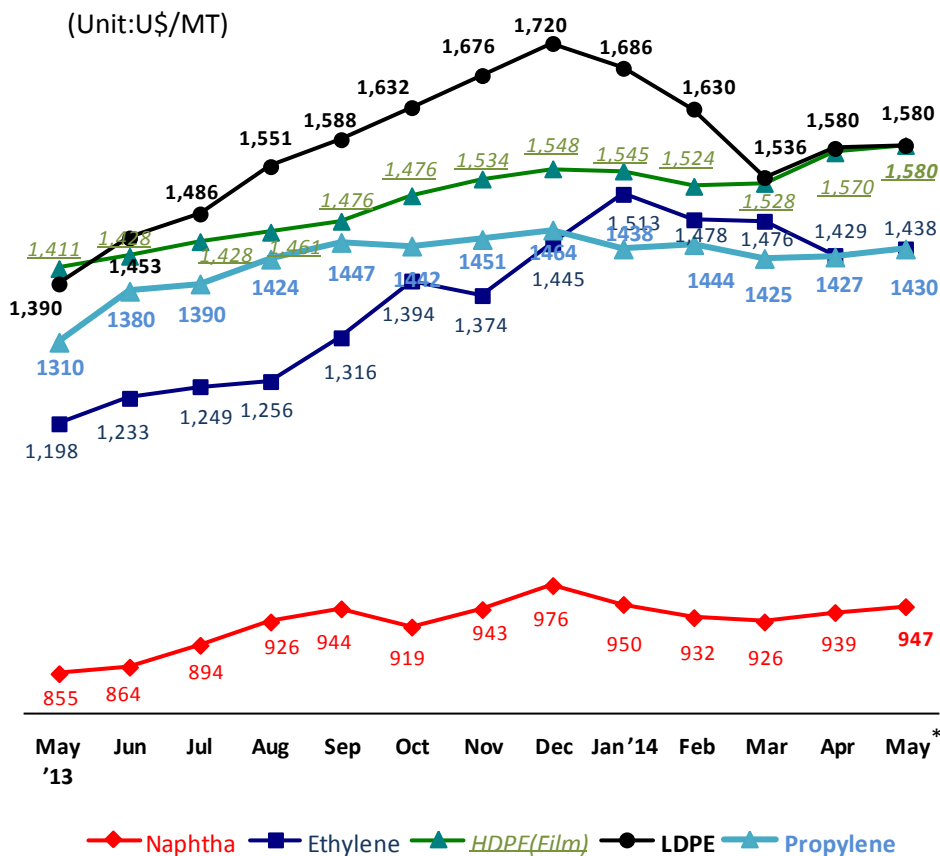

NCC/PO

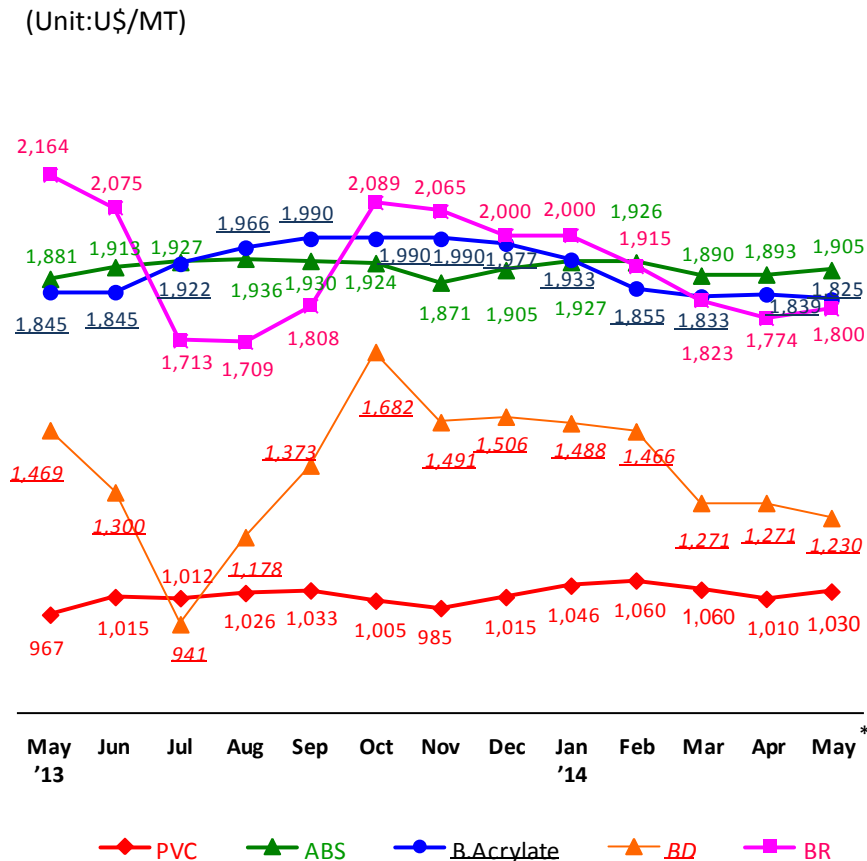

PVC/
Plasticizer

ABS/EP

Acrylate/
SAP

Rubber/
Specialty Polymers

• The prices are average price of CFR FE Asia for general grade in each product group.

* shows the prices on 16th May, 2014.

As of 1st quarter of 2014

	Item	Location	Capa	Global Rank	Capa Additions
Petro-Chemicals	ABS (Acrylonitrile-Butadiene-Styrene)	Korea, China	1,390 KMT/Yr	1st*	
	PVC (Polyvinyl Chloride)	Korea, China	1,270 KMT/Yr	6th	
	Oxo-Alcohol	Korea (Yeosu, Naju)	299 KMT/Yr	10th	
	AA (Acrylic Acid)	Korea (Yeosu, Naju)	353 KMT/Yr	6th	
	PC (Polycarbonate)	Korea (Yeosu)	170 KMT/Yr	6th	
	BR (Butadiene Rubber)	Korea (Daesan)	180 KMT/Yr	7th	
	Elastomer	Korea (Daesan)	85 KMT/Yr	4th	
	SAP (Super Absorbent Polymer)	Korea (Gimcheon, Yeosu)	260 KMT/Yr	5th	[80K added in 1Q 2014]
	MBS (Methacrylate-Butadiene-Styrene)	Korea (Yeosu)	50 KMT/Yr	4th	
	NBL (Acrylonitrile-Butadiene-Latex)	Korea (Yeosu)	100 KMT/Yr	2nd	
I & E Materials / Energy Solution	BPA (Bisphenol A)	Korea (Yeosu)	430 KMT/Yr	5th	
	Polarizer	Korea (Ochang), China	137 mn m ² /Yr	1st	[20mn m ² /Yr will be added in 2Q 2014]
	Consumer Battery (Lithium-ion)	Korea (Ochang), China	95 mn cells/Month**	2nd	[2mn cells will be added in 1H 2014]
	EV/HEV Battery (Lithium-ion)	Korea (Ochang), US	140K Units/Yr***	1st	
	Color Filter Photoresists	Korea (Ochang)	-	2nd	
	3D FPR	Korea (Ochang)	-	1st	

★ Actual Sales Base

★★ Cylindrical : 41 mn, Prismatic : 26 mn, Polymer : 28 mn

★★★ Convert to GM 'VOLT' base.

Shareholders & Market Cap

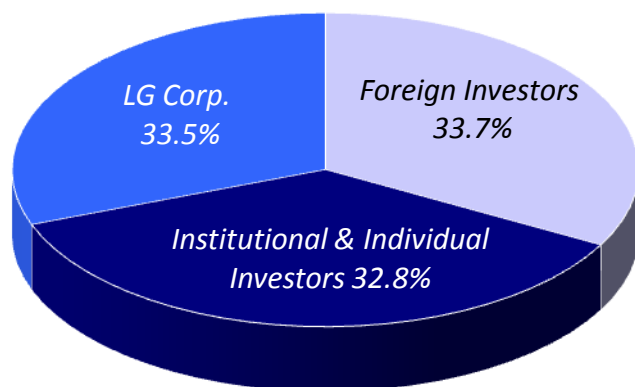

Common Stock as of May 22, 2014

(Unit : KRW)

	No. of Shares	May 22, '14	
		Price	Market Cap
Common	66,271,100	267,000	17.7 tn
Preferred	7,628,921	161,000	1.2 tn
Total	73,900,021		18.9 tn

Par value : KRW 5,000

Dividends

(Unit: KRW bn)

Classification	'12	'13	Change
Net Income	1,506	1,271	-15.6%
EPS(KRW)	20,318	17,211	-15.3%
Total Dividends	295*	295*	0
Dividend Payout Ratio	21.0%	24.3%	+3.3%p
Common Stock Price at year-end(KRW)	330,000	299,500	-30,500
Dividend Yield Ratio	1.2%	1.3%	+0.1%p

* Dividend of KRW 4,000 per common share