

1Q 2009 Business results & Outlook

June 2009



The business results for 1Q 2009 currently under audit review are presented here for investors' convenience. Hence, please be advised that some of their contents may be altered in the course of audit.

Forecasts and projections contained in this material are based on current business environments and management strategies, and they may differ from the actual results upon changes and unaccounted variables.

Table of Contents

LG Chem at a Glance	1
Mid to Long-term Business Strategy	2
Distinctive Vertical Integration	3
1Q 2009 Business Results	4
Divisional Results & Outlook	8
2009 Business Plan	10
Appendix	11

LG Chem at a Glance

- LG Chem was started in 1947 and is Korea's first and largest blue chip chemical company with an established track of over 60 years and annual revenues of KRW 16.7 trillion in 2008
- LG Chem boasts multiple production facilities and an extensive distribution network that spans 15 countries worldwide in Asia, Europe, North and South America
- LG Chem currently holds the largest vertically integrated petrochemical production platform in Korea
- Due to inconsistencies of strategic directions such as corporate culture and customer base with existing businesses, the demerger of industrial materials business was completed on April 1, 2009
- LG Chem was reborn as a specialized and diversified chemical company that focuses on petrochemical goods, small and mid-to large sized-batteries for automobiles, and electronic materials

Impressive Revenue Scale...

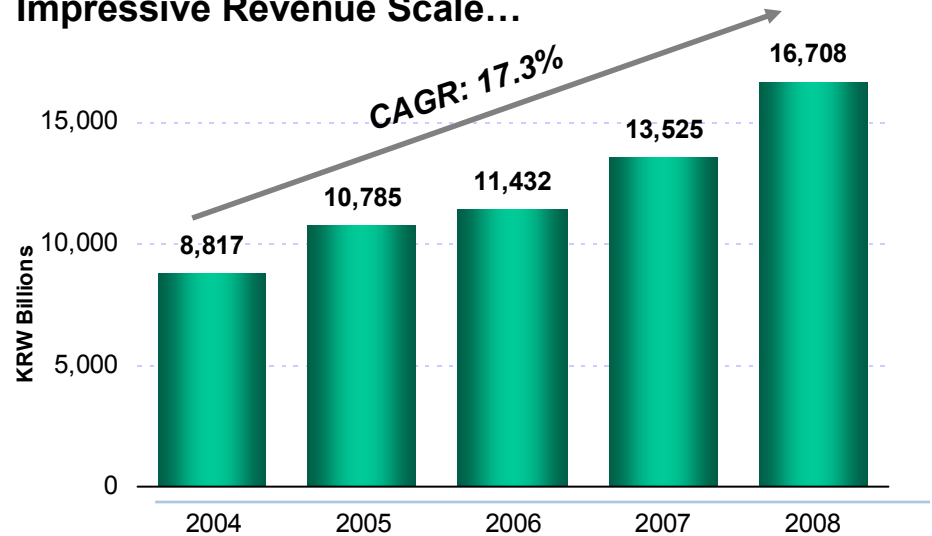

...with Strong EBITDA & EBITDA Margins

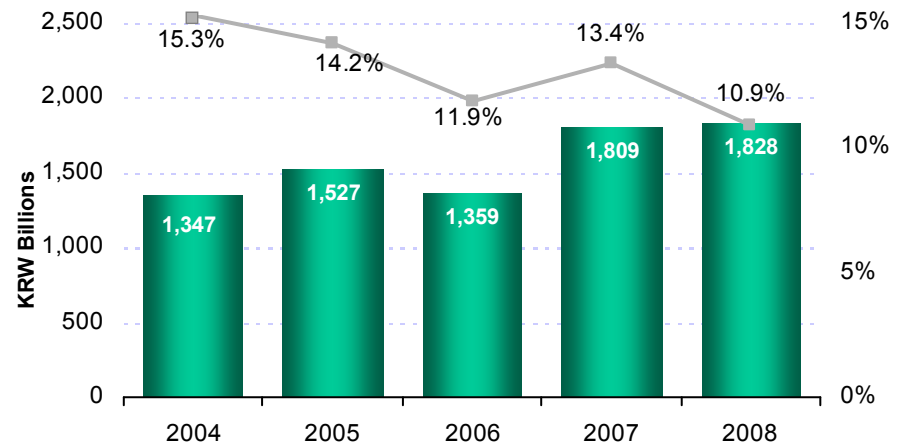

Mid to Long-term Business Strategy

Business Portfolio

- Petrochemicals
- I&E Materials

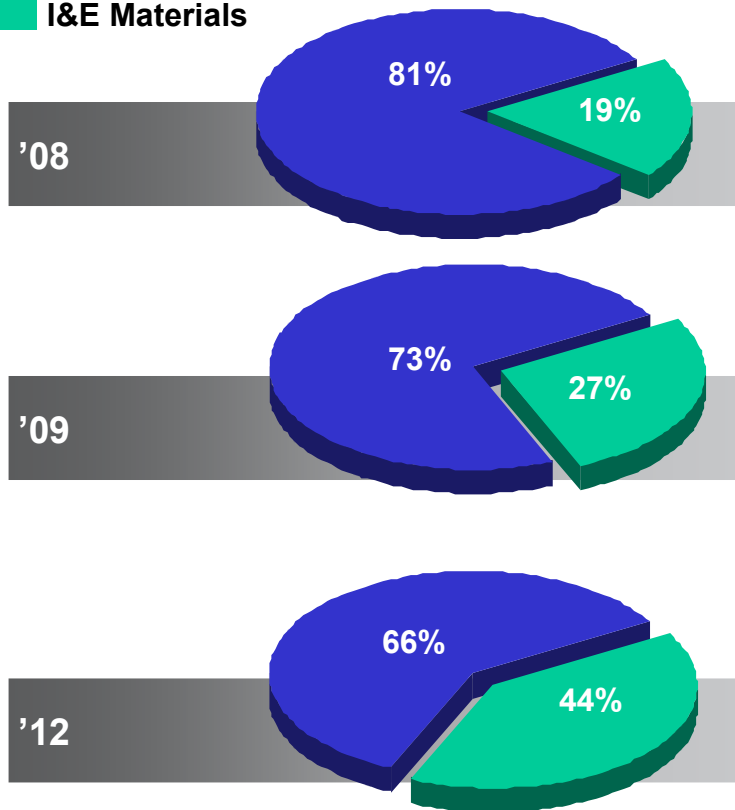

Strategy

Business

Strategy

Petrochemicals

- ✓ Optimizing the businesses
- ✓ Focusing on value-added downstream products
- ✓ Securing long-term competitiveness of China businesses
- ✓ Investing overseas via J/V

I & E Materials

- ✓ Optical materials- sustain profitable growth
- ✓ Battery- strengthen the position in Top 5 customers

New Business

- ✓ HEV/EV Battery
- ✓ LCD Glass

Distinctive Vertical Integration

Vertical Integration Structure

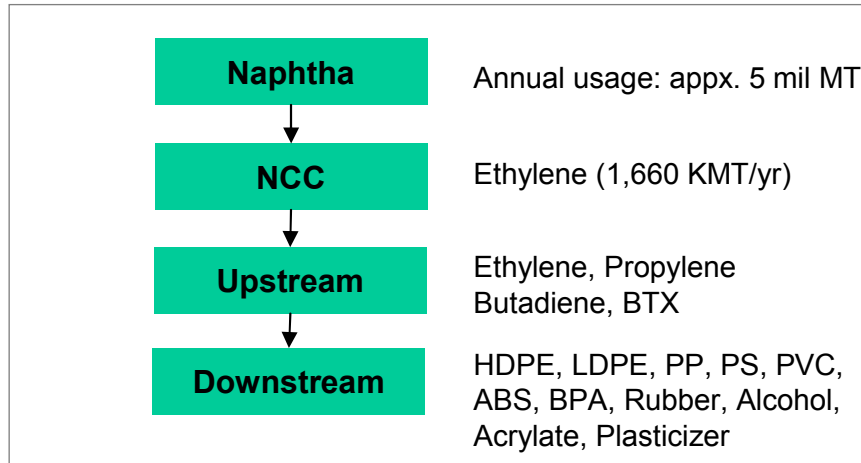

Co-existence of upstream and downstream products

- One of few petrochemical companies around the globe with a vertical integration structure, featuring both upstream and downstream production capability
- This structural characteristic delivers stable business performance against industry cyclicalty

Comprehensive downstream product lines

LG Chem's comprehensive downstream product lines of PO, ABS, PVC and other various products have complementary business cycles, enabling the Company to generate stable revenue

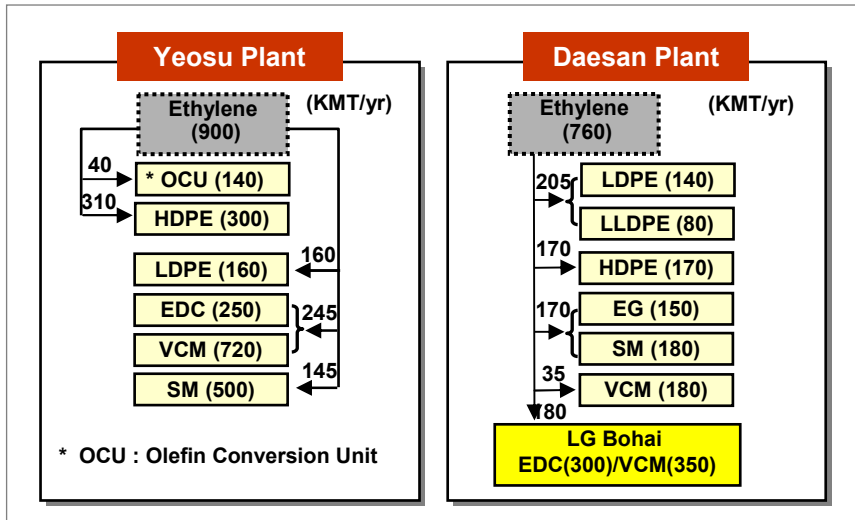

Stabilized revenue generating capability under any market conditions

1Q 2009 Business Results

Consolidated

(Unit:KRW bn)

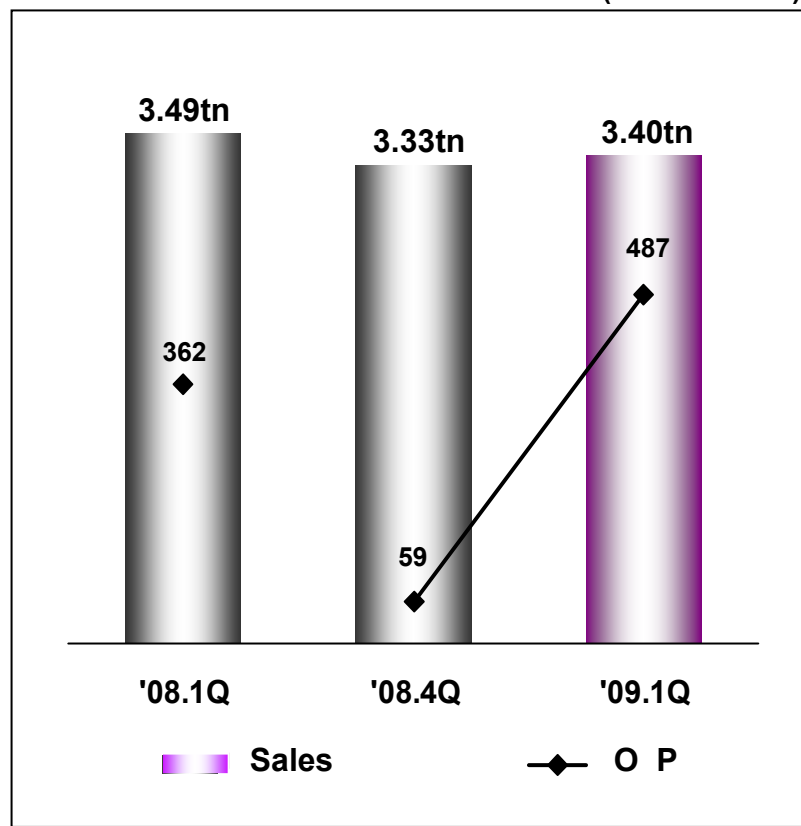

Non-consolidated

(Unit:KRW bn)

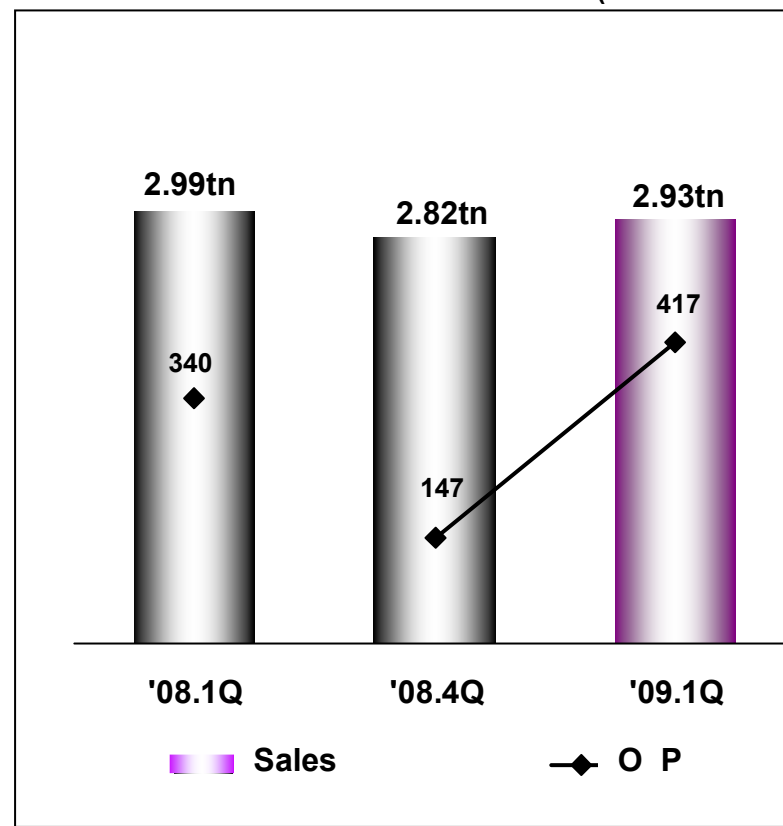

1Q 2009 Business Results

Non-consolidated

(Unit:KRW bn)

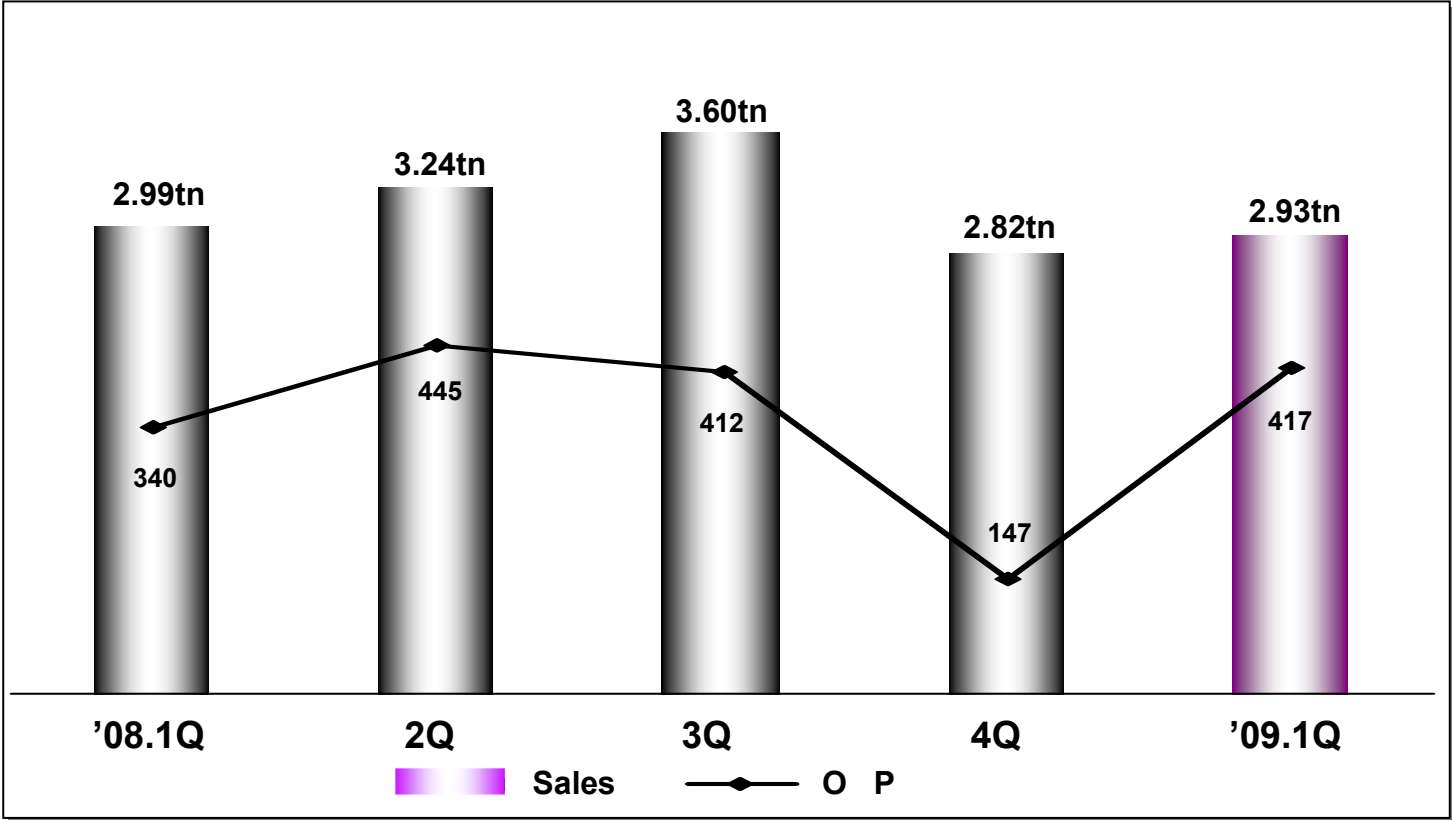

(Unit : KRW bn)	Consolidated				Non-Consolidated			
	'08.1Q	'08.4Q	'09.1Q	YoY	'08.1Q	'08.4Q	'09.1Q	YoY
Sales	3,494	3,332	3,400	-2.7%	2,994	2,816	2,932	△2.1%
Operating Profit	362	59	487	34.6%	340	147	417	22.4%
(%)	(10.4)	(1.8)	(14.3)		(11.4)	(5.2)	(14.2)	
Pre-tax Income From Continuing Operations	318	27	444	39.4%	315	94	426	35.1%
(%)	(9.1)	(1.0)	(13.1)		(10.5)	(3.3)	(14.5)	
Equity Method Gains	2	-9	1	-70.6%	12	-62	35	178.2%
Net Income	258	62	289	11.6%	258	62	289	11.6%

	Consolidated			Non-Consolidated		
(Unit : KRW bn)	'08	'09.1Q	Apr 1,'09	'08	'09.1Q	Apr 1,'09
Assets	9,736	10,371	9,110	8,036	8,623	7,502
(Cash and equivalents)	514	1,126	905	373	968	754
Liabilities	4,683	5,205	4,611	3,147	3,632	3,172
(Borrowings)	2,743	2,909	2,565	1,350	1,539	1,327
Shareholder's Equity	5,053	5,166	4,500	4,890	4,991	4,330
Total Liabilities / Equity (%)	92.7	100.8	102.5	64.4	72.8	73.2
Debt / Equity (%)	54.3	56.3	57.0	27.6	30.8	30.6
Interest Coverage Ratio	13.5	19.6	-	34.3	41.7	-
ROE (%)	21.7	23.3	-	24.5	23.4	-
ROA (%)	10.8	11.8	-	13.9	13.9	-
EBITDA	1,864	626		1,746	522	

Business results

Analysis

(Unit:KRW bn)

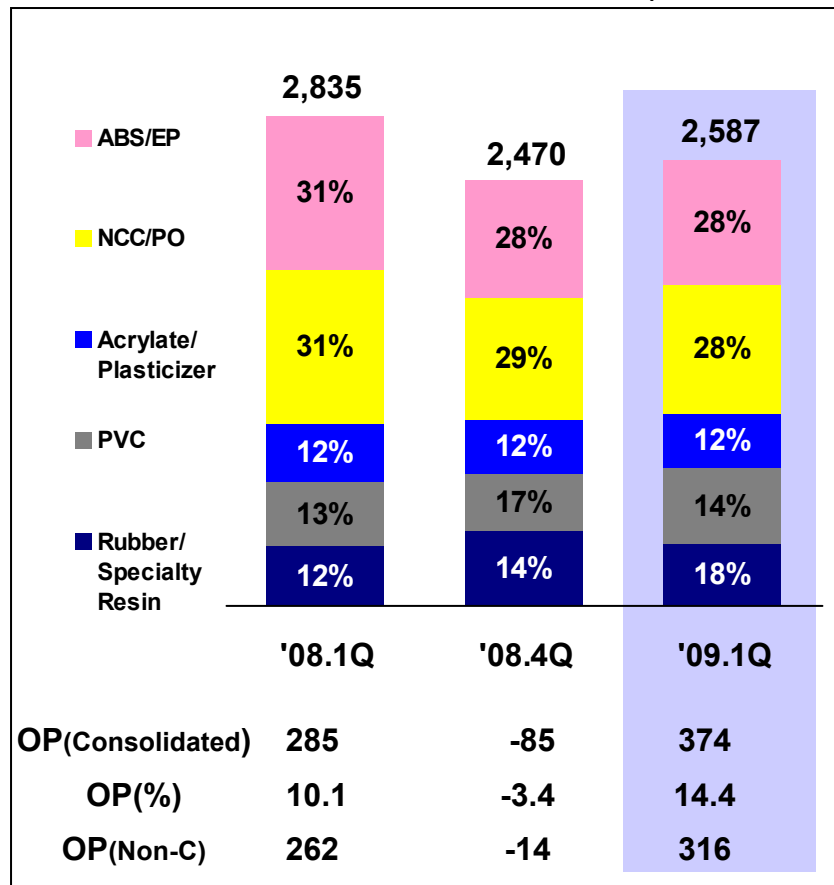

• Analysis

- China's economic stimulus measures led rapid rebound of product demand and prices
- Significant improvement of spread due to low-cost raw material input
- Strong inventory build-up demand
- Increase in profitability attributable to weak Korean won
- Products less impacted by economy recession retrieved high profitability (Acrylate etc.)

• Outlook

- Solid trend of product prices will be sustained backed by seasonal demand in 2Q
- Reduced benefit from weak Korean won will result profitability adjustment

Business results

Analysis

(Unit:KRW bn)

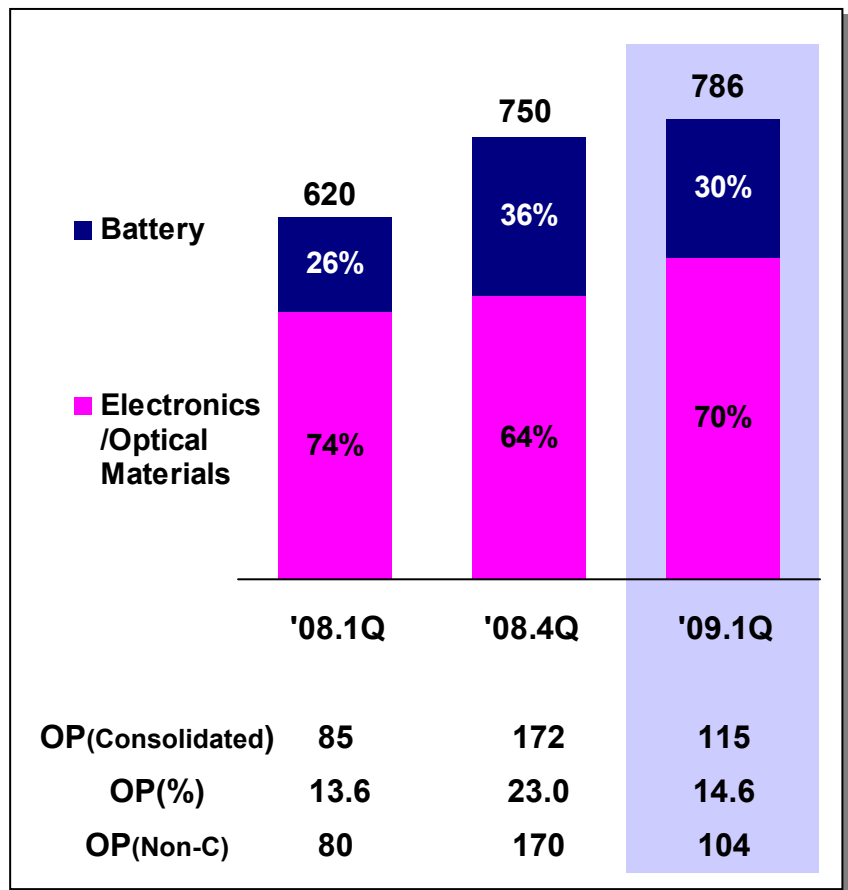

• Analysis

■ Electronics & opticals

- Rebound of utilization in LCD panel makers due to demand increase in China
- Raw material cost burden from strong Japanese Yen resulted in slight margin decrease

■ Battery

- Price drop stemming from weak demand in global economy slowdown & seasonality pushed down profitability

• Outlook

■ Electronics & opticals

- Full operation of ultra-wide line & continuous achievement of cost cut
- Gradual volume increase on the back of robust demand in LCD panel makes

■ Battery

- Sales increase to top customers such as Nokia etc.

2009 Business Plan

Business Plan

(Unit:KRW bn)

Item	Consolidated		Non-consolidated	
	'08	'09(P)	'08	'09(P)
Total Sales	14,500	12,600	12,600	11,100
Petro-chemicals	11,800	9,300	10,000	7,700
I&E	2,700	3,400	2,700	3,500
CAPEX	732	1,048	640	864

Cash Flow

(Unit:KRW bn)

Item	Amounts
Cash Inflow	1,617
From Operating	1,239
Depreciation	378
Cash Outflow	1,242
CAPEX	864
Working capital	169
Dividend	209
Net Cash flow	375

Key Investment

(Unit:KRW bn)

■ Petrochemicals	<u>263</u>
-Acrylate debottlenecking, etc.	104
■ I&E	<u>465</u>
-Battery, HEV Battery, Electrode, etc.	347
■ Common	<u>136</u>
-Maintenance, etc.	

(Unit: KRW bn)

LGC	2008					2009				
	1Q	2Q	3Q	4Q	Total	1Q	2Q	3Q	4Q	Total
Sales	3,494	3,749	3,980	3,332	14,555	3,400				3,400
Operating Profit	362	484	416	59	1,321	487				487
Petrochemicals	2,835	3,131	3,380	2,470	11,816	2,587				2,587
NCC/PO	884	977	1,074	703	3,638	751				751
Synthetic Rubber/ Specialty Resin	353	400	516	434	1,703	358				358
PVC	370	412	493	335	1,609	439				439
ABS/EP	891	965	908	692	3,456	724				724
Acrylate/Plasticizer	337	379	388	306	1,410	315				315
Operating Profit	285	393	319	-85	912	374				374
I & E Materials	620	654	654	750	2,678	786				786
Optical/Electronic	462	516	511	492	1,981	556				556
Battery	165	148	154	272	739	242				242
Operating Profit	84	102	107	172	466	115				115

(Unit: KRW bn)

LGC	2008					2009				
	1Q	2Q	3Q	4Q	Total	1Q	2Q	3Q	4Q	Total
Sales	2,994	3,239	3,597	2,816	12,645	2,932				2,932
Operating Profit	340	445	412	147	1,344	417				417
Petrochemicals	2,397	2,607	2,961	2,075	10,039	2,152				2,152
NCC/PO	884	985	1,085	720	3,674	777				777
Synthetic Rubber/ Specialty Resin	347	381	503	395	1,626	338				338
PVC	259	286	341	237	1,124	295				295
ABS/EP	583	604	653	430	2,271	432				432
Acrylate/Plasticizer	323	350	378	294	1,344	310				310
Operating Profit	262	350	310	-14	907	316				316
I & E Materials	611	656	669	769	2,705	804				804
Optical/Electronic	445	505	505	478	1,933	546				546
Battery	173	160	174	304	811	269				269
Operating Profit	80	98	105	170	453	104				104

Borrowings

(Unit : KRW bn)

	Balance			'09 Plan
	'08	'09.1Q	'09.4.1	
Total	1,350 (100%)	1,539 (100%)	1,327 (100%)	1,099 (100%)
KRW	929	1,078	865	638
Currency	(69%)	(70%)	(65%)	(62%)
C P	-	-	-	-
C B	560	710	500	350
Others	369	368	365	288
Foreign	421	461	461	461
Currency	(31%)	(30%)	(35%)	(38%)
FRN	170	186	186	186
Others	252	275	275	275
Short-term	560 (42%)	671 (44%)	671 (51%)	271 (40%)
Long-term	790 (58%)	869 (56%)	656 (49%)	829 (60%)

☞ The % is calculated to total borrowings. Discounts of bond is not included.
Currency swap included

Cash Flow

(Unit : KRW bn)

	'08	'09.1Q
Beginning	466	373
Operating/Investing	246	426
Net Income	1,003	321
Depreciation	402	91
Working Capital	-534	207
CAPEX	-713	-194
Others	88	-
Financing	-339	-23
Borrowings	-12	-23
ABS refund	-160	-
Dividend	-167	-
LG Hausys Spin-off	-	-23
Cash split		--214
Borrowings split		212
Working Capital, etc. (LG Hausys)		-21
End	373	754

(Unit : KRW bn)

		'07	'08	'09 Plan	'09.1Q
Petrochemicals	New/Expansion	142	217	104	33
	Maintenance	68	85	136	27
	Equity Investment	16		23	
	Total	227	302	263	60
I & E Materials	New/Expansion	42	194	347	61
	Maintenance	36	51	91	11
	Equity Investment	12	21	28	11
	Total	90	266	466	83
Common Expenses	New/Expansion	1			12
	Maintenance	100	71	136	20
	Equity Investment		1		19
	Total	100	72	136	51
Total	New/Expansion	185	411	451	106
	Maintenance	204	207	363	57
	Equity Investment	28	22	50	30
	Total	417	640	864	194

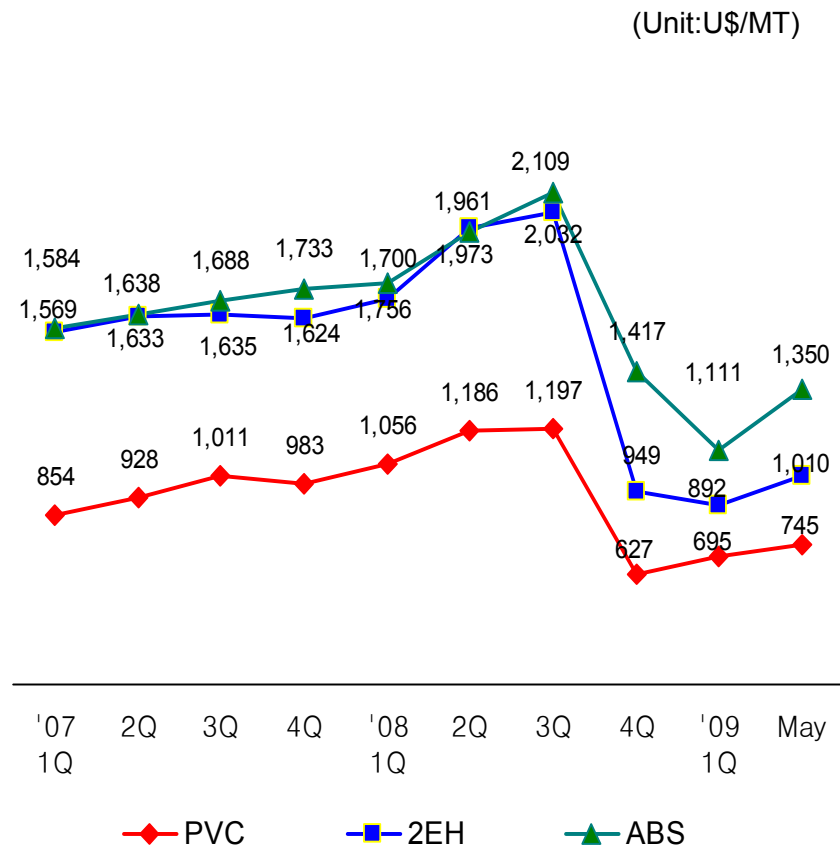
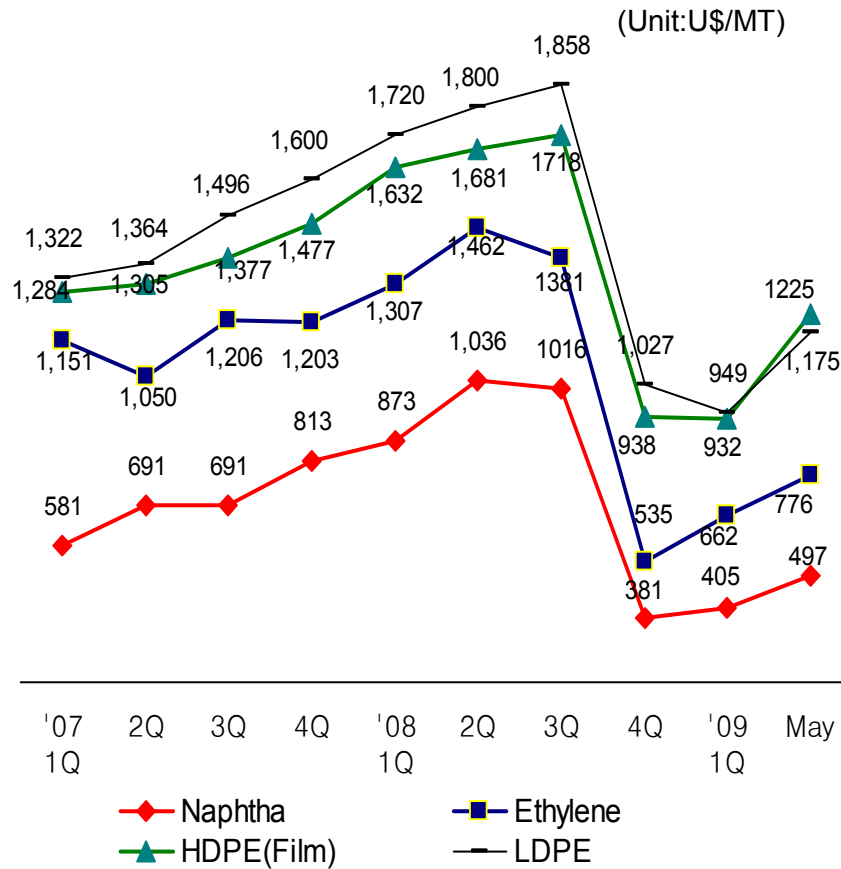

• The prices are average price of CFR FE Asia for general grade in each product group.

Shareholders & Market Cap

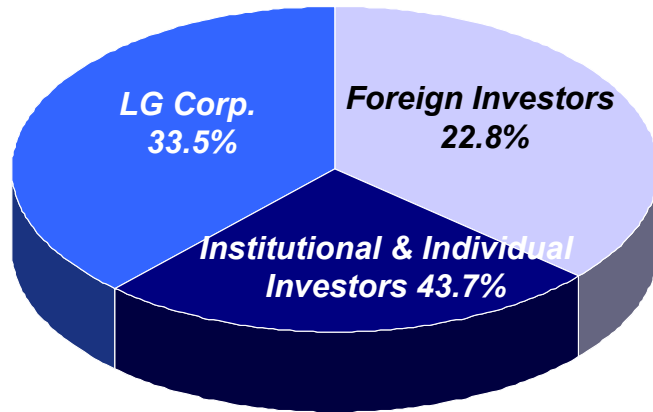

Common Stock as of May 28, 2009

(Unit : KRW)

	No. of Shares	May 28, '09	
		Price	Market Cap
Common	66,271,100	146,500	9.7 tn
Preferred	7,628,921	52,500	0.4 tn
Total	73,900,021		10.1 tn

Par value : KRW 5,000

GDR Info.

Listed in LSE
144A GDR
Reg.S GDR

ORD:GDR Ratio: 1:2
Exchange: PORTAL
Ticker: LGCLY US
ISIN: US5019551085

Exchange: London Stock Exchange
Ticker: LGCD LI
ISIN: US5019551085

** The exchange, ticker and ISIN info will not change and remain the same as long as there are no change on the listing status.*